

LIGHT & TIME CONTROLS TO SAVE ENERGY FOR OVER 50 YEARS.

PMC-CAT-02-10

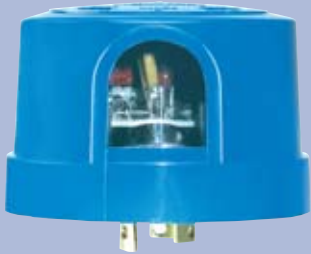

Street Light
Lock Type
Photocontrol



Direct Wire In
Photocontrol



Button-Type
Photocontrol

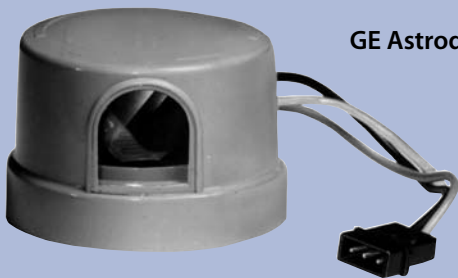

GE Astrodome

Obstruction Lighting
Control For FAA &
FCC Requirements



Energy Saver
Specialty Control



Easy On/Off Field
Setting On Base.



Swivel
Type

Low Voltage
Controls



Lighting
Contactor
30 & 60 AMP



24 Hour
40 AMP
Time Switch



OVER 250 PRODUCTS TO SAVE YOU ENERGY!

CUSTOMER SERVICE ALWAYS AVAILABLE BY PHONE 9AM TO 5PM WEEKDAYS EST 201-444-0600

Direct Wire-In Photocontrols (120 - 480 Volts)

**Heavy-duty
Die-cast
Enclosure**



**Vandal
Proof**

Lumatrol® "T" Series

Cast Aluminum Housing photocontrols - Designed for those locations where high vandalism creates high maintenance. The heavy-duty cast aluminum housing is 20 times more resistant to high-impact objects (i.e. rocks, bats or small projectiles) than plastic housing. As the controlling element of the total lighting package (fixture, lamp ballast) and the least costly component, it is most important that the control continue to function under all adverse conditions.

Specifications	
Housing:	Vandal proof die cast aluminum housing.
Photocell:	Broad surface sensing element.
Turn-on:	1 to 3 foot-candles. External light level slide allows field adjustment between 3 to 10 foot-candles.
Turn-on/ Turn-off Ratio:	1:3
Switch Type:	Single-pole, single-throw. Contact position at night normally closed.
Time Delay:	Minimum 15 seconds.
Temperature Range:	-40° to 170° F.
Lead Wire:	Moisture proof, color coded lead wire. Wire length: 6 inches.
Threaded Stem:	1/2 inch-14 thread, and fits 1/2 inch knock out.
Dimensions:	3" high, 2" wide, 1-3/8" deep.

Model	Voltage	Rating
T-15-AL	120	1800 VA
T-168-AL	208-277	1800 VA
T-30-AL	120	3000 VA
T-368-AL	208-277	3000 VA



Lumatrol® "T-30" Wire-In Photo Control - 3000 Watts

Designed for those applications which demand more load switching than standard 15 amp. series can handle.

Specifications	
Housing:	Lexan enclosure.
Photocell:	Broad surface sensing element.
Turn-on:	1 to 3 foot-candles. External light level slide allows field adjustment between 3 to 10 foot-candles.
Turn-on/ Turn-off Ratio:	1:3
Switch Type:	Single-pole, single-throw. Contact position at night normally closed.
Time Delay:	Minimum 15 seconds.
Temperature Range:	-40° to 170° F.
Power Consumption:	1.1 watts average at 120 VAC.
Rated Life:	5,000 operations minimum at rated load.
Threaded Stem:	1/2 inch-14 thread, and fits 1/2 inch knock out.
Dimensions:	3" high, 2" wide, 1-3/8" deep.

Model	Voltage	Rating
T-30	120	3000 VA
T-368	208-277	3000 VA

**All Precision photocontrols
are 100% compatible with
compact fluorescent lamps.**



Direct Wire-In Photocontrols (120 - 480 Volts)

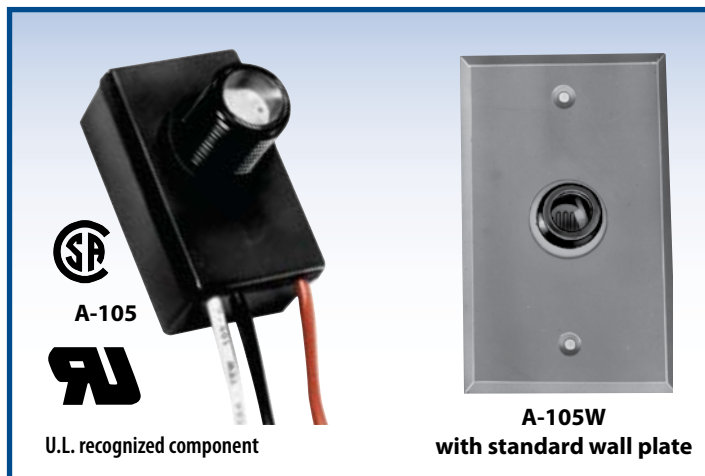
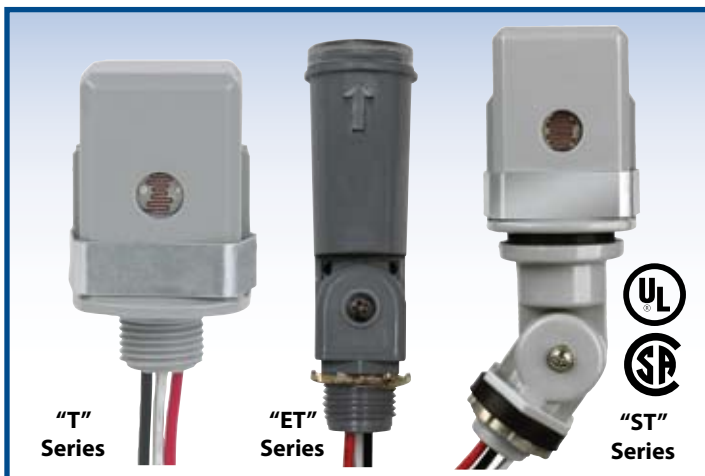

Lumatrol® "T", "ET" & "ST" Series Wire-In Photocontrols

Lumatrol® "A" Series Wire-In Photocontrols

Specifications	
Housing:	Weatherproof Lexan® housing.
Photocell:	Broad surface sensing element.
Turn-on:	1 to 3 foot-candles. External light level slide allows field adjustment between 3 to 10 foot-candles.
Turn-on/ Turn-off Ratio:	1:3
Switch Type:	Single-pole, single-throw. Contact position at night normally closed.
Time Delay:	Minimum 15 seconds.
Temperature Range:	-40° to 158° F.
Lead Wire:	Moisture proof, color coded lead wire. Wire length: 6 inches.
Threaded Stem:	1/2"-14 thread, and fits 1/2" knock out. Swivel T-Series (ST) is equipped with a swivel mount which allows installer to swivel light sensitive element to the best position for operation.
Dimensions T Series:	2" high, 1-1/2" wide, 1" deep.
ST Series:	2" high, 1-1/2" wide, 1" deep (body); 2" high, (stem).
ET Series:	3 1/2" high, 1" diameter

Specifications	
Housing:	Durable, high impact Lexan® housing, ultrasonically welded for maximum strength. Nylon locknut provided. Compact in size, A-105 can be mounted directly within a lighting fixture or in lighting standards that are 2 inches in diameter or larger.
Photocell:	Broad surface sensing element.
Turn-on:	1 to 3 foot-candles.
Turn-on/ Turn-off Ratio:	1:3
Switch Type:	Single-pole, single-throw. Contact position at night normally closed.
Time Delay:	Minimum 15 seconds.
Temperature Range:	-30° to 140° F.
Lead Wire:	Color coded lead wire. Wire length: 15 inches.
Threaded Stem:	3/8 inch-18 thread; threaded stem 3/4 inches long.
Dimensions:	2" high, 1-1/4" wide, 3/4" deep (1-1/2" deep including threaded stem).

Note: The body or housing of model A-105 must be mounted in a weather proof enclosure to assure protection from water damage. Only threaded portion is weather proof.

Model	Voltage	Rating
ST-15*, T-15*	120	1800 VA
ST168, T-168†	208-277	1800 VA
ST-19**, T-19**	480	1800 VA
ST-347†**	347	1800 VA
ET-15	120	1800 VA
ET-168	208-277	1800 VA

** Dimensions: 3" high, 2" wide, 1 3/8" deep.

* UL listed & CSA certified. † CSA certified only.

Model	Voltage	Rating
A-105*	120	1000 VA
A-1068*	208-277	1000 VA
A-347†	347	1000 VA
A-105W†**	120	1000 VA
A-1068W**	208-277	1000 VA

** Complete with gasketed metal wall plate (2 3/4" x 4 1/2"), mounting screws, and two nylon locknuts so that units will fit any standard outlet box.

* UL Recognized & CSA Certified † CSA Certified only.

For Direct Wire, Low Voltage Applications



Lumatrol® Low Voltage “Stem Mount” Photocontrols

Specifically designed for a 12 volt DC, or 24 volt AC/DC battery operated light source or low voltage control circuits. Rated at 70° C to operate in high temperatures near solar modules.

Specifications	
Housing:	Weatherproof Lexan® housing.
Turn-on:	1 to 3 foot-candles.
Turn-on/ Turn-off Ratio:	1: 1.5
Switch Type:	Single-pole, single-throw. Contact position at night normally closed.
Time Delay:	1-5 seconds.
Threaded Stem:	1/2 inch-14 thread, and fits 1/2 inch knock out. Swivel Series is equipped with a swivel mount which allows installer to swivel light sensitive element to the best position for operation.
Dimensions :	2" high, 1-1/2" wide, 1" deep.
Power Dissipation:	12-1/2 MA@ 12VDC

“LCS” Series

Model	Voltage	Rated Load
LCS-612D	12 VDC	10 AMP†
LCS-624D	24 VDC	10 AMP†
LCS-624A	24 VAC	10 AMP†

† Non-inductive.

Lumatrol® Low Voltage “Button Type” Photocontrols

Specifically designed for use inside compatible light fixtures or in weatherproof enclosures 2" in diameter or larger.

Specifications	
Housing:	Durable, high impact Lexan® housing, ultrasonically welded for maximum strength. Nylon locknut provided. Compact in size, LCA series can be mounted directly within a lighting fixture or in lighting standards that are 2 inches in diameter or larger.
Turn-on:	1 to 3 foot-candles.
Turn-on/ Turn-off Ratio:	1:1.5
Switch Type:	Single-pole, single-throw. Contact position at night normally closed.
Time Delay:	1-5 seconds.
Threaded Stem:	3/8 inch-18 thread; threaded stem 3/4 inches long.
Dimensions:	2" high, 1-1/8" wide, 1-3/4" deep (2" deep including threaded stem).

“LCA” Series

Model	Voltage	Rated Load
LCA-612D	12 VDC	10 AMP
LCA-624A	24 VAC	10 AMP
LCA-624D	24 VDC	10 AMP

LOW VOLTAGE PHOTOCONTROLS WIRING DIAGRAMS

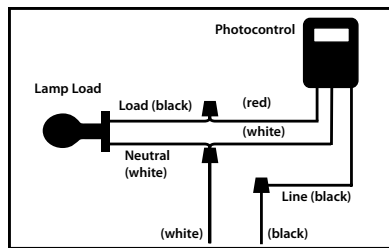

24 VAC



48, 24 & 12 VDC

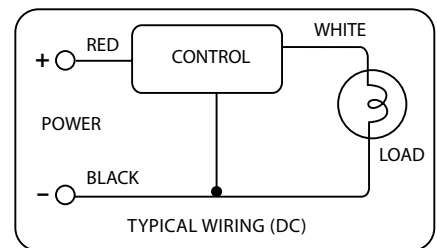

Locking Type, Low Voltage Lighting Applications



Available in 48 VDC, 24VDC & 12 VDC
 Rated at 170° F to operate in high temperatures near solar models.

Twistlock format for easy plug n play replacement.

LCP Specifications

Housing:	UV stabilized high-impact polypropylene
Sensor:	Sealed Silicon Sensor
Turn-on:	1 to 3 foot-candles
Turn-on/ Turn-off Ratio:	1:1.5
Switch Type:	Single-pole, single-throw. Contact position at night normally closed.
Time Delay:	1 to 5 seconds.
Temperature Range:	-40° to 170° F
Power Dissipation:	10 MA
Rated Life:	5,000 operations minimum at rated load
Surge Protection:	MOV (Metal Oxide Varistor)
Dimensions:	3.07" diameter, 2.15" high.

Locking Type Control

Model	Voltage	Rated Load
LCP-48	48 VDC	10 AMP
LCP-24	24 VDC	10 AMP
LCP-12	12 VDC	10 AMP

Locking Type Receptacle

Model M2ANB-LV for all low voltage, locking type control applications. Comes with housing and receptacle (½" threaded stem).

Model	Voltage	Rated Load
M2ANB-LV	12, 24 & 48 VDC	10 AMP

M2ANB-LV Specifications

Locking-type, polarized receptacle with 14" 14 AWG color coded leads

Leads: Red (+). Black (-) and Orange (Load).

Dimensions: 2 5/8" high (incl. ½" stem), diameter 2 3/4"

DO NOT USE WITH AC RECEPTACLES!

Precision's low-voltage twistlock system is designed for low voltage DC use only! To avoid damage must be used with Precision's low-voltage, polarized base, model M2ANB-LV.

LCP Low Voltage Wiring Diagrams

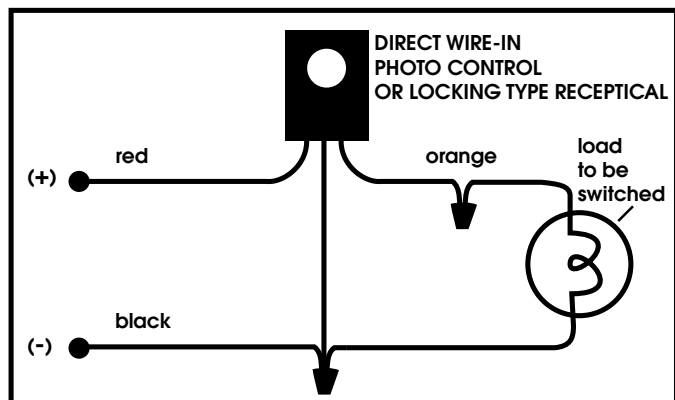

DC color codes:
 Red = Positive (+)
 Orange = Load
 Black = Line (-)

30 AMP Model



Low Voltage
30 AMP Series
 Extra Load capacity for more demanding applications

Features heavy duty SPST 30 AMP Switching Relay

With (2 3/4" x 4 1/2") wall plate and aluminum splice box**

"LCA" Series

Model	Voltage	Rated Load
LCA-612D-30	12 VDC	30 AMP
LCA-624A-30	24 VAC	30 AMP
LCA-624D-30	24 VDC	30 AMP

** Complete with gasketed metal wall plate, mounting screws, and two nylon locknuts and aluminum splice box so that units will fit any standard outlet box.

Locking-Type Photocontrols (120 - 285 Volts)

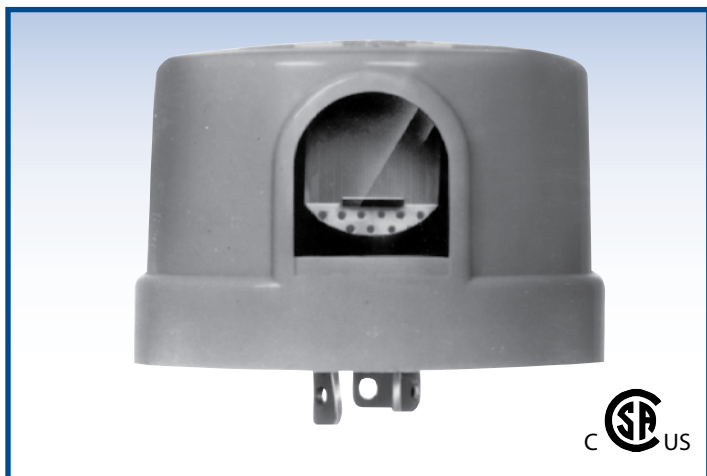

Locking-Type Photocontrols- Delayed Response Thermal Series

Built-in time delay prevents false cycling caused by lightning flashes or stray headlights.

Meets ANSI utility standards.

Specifications	
Housing:	UV stabilized high-impact polypropylene.
Sensor:	1/2" cadmium sulfide light sensitive element.
Turn-on:	1 to 3 foot-candles.
Turn-on/ Turn-off Ratio:	1:3.
Switch Type:	Single-pole, single-throw. Contact position at night normally closed.
Time Delay:	Minimum 15 seconds.
Temperature Range:	-40° to 170° F.
Power Consumption:	1.1 watts average at 120 VAC.
Rated Life:	5,000 operations minimum at rated load.
Surge Protection:	MOV (Metal Oxide Varistor). 320 joule rating. Add suffix "MOV"
Dimensions:	3.07" diameter, 2.15" high.

Standard Series with Surface Passivated Cell

Model	Voltage	Rating
P2275	120	1800 VA
P68275	208-277	1800 VA
P7275	480	1800 VA
LM347	347	1800 VA
LM600	600	1800 VA

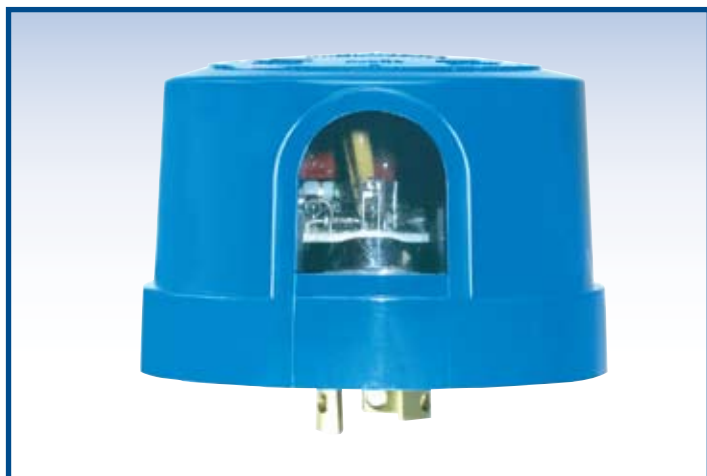

Electronic Utility-Grade Series State-of-the-Art Electronic Design

1 to 1.5 on/off ratio for maximum energy savings.

Meets or exceeds Ansi C136:10 & UL773

Specifications	
Housing:	UV stabilized high-impact polypropylene.
Sensor:	Sealed Silicon Sensor
Turn-on:	1.5 foot-candles on.
Turn-on/ Turn-off Ratio:	1:3
Switch Type:	Single-pole, single-throw. Contact position at night normally closed.
Time Delay:	3-5 seconds
Temperature Range:	-40° to 170° F.
Power Consumption:	Less than 1 watt per day.
Rated Life:	5,000 operations minimum at rated load.
Surge Protection:	320 Joule MOV (Metal Oxide Varistor).
Base:	125°C High Temp.

Model	Voltage	Rating
EC120-AP-TD	120 V	1800 VA
EC240-AP-TD	240 V	1800 VA
ECDV-AP-TD	105-285 V	1800 VA dual voltage

Housings are color-coded per ansi spec

120 V = Grey

208-277 V = Maroon

105-285 V = Blue

Photo-Timer = Green (ESC-124DS)

Special Photocontrols & Accessories

Explosion Proof Photocontrols



"A" Style



"T" Style

Lumatrol® "A" and "T" Style

Specifications

Housing:	Explosion-proof cast aluminum housing. Removable threaded cover with glass window.
Compliance:	N.E.C. Hazardous (Classified) Locations: Class I, Division 1 & 2, Groups C, D Class II, Division 1 & 2, Groups E, F, G Class III NEMA 7 CD, 9 EFG
Dimensions:	"A" Series Explosion Proof 4-5/8" high, 3" wide, 3-1/8" deep. "T" Series Explosion Proof 4-3/4" wide, 4-3/4" high and 4-1/2" deep.
Turn-on:	2 to 2.5 foot-candles.

"A" Style Explosion Proof Series

Model	Voltage	Rating
A-105EP*	120	1000 VA
A-1068EP*	208-277	1000 VA
A-347EP	347	1000 VA

*Add 5/8" (height) for each wall mounting lug & 7/8" (depth) for lens extension

"T" Style Explosion Proof Series

Model	Voltage	Rating	Model	Voltage	Rating
T-15EP*	120	1800 VA	T-19EP	480	1800 VA
T-168EP*	208-277	1800 VA	T-30EP	120	3000 VA
T-347EP	347	1800 VA	T-368-EP	208-277	3000 VA

* Refer to page 3 for UL & CSA listings on photocontrols



Jumper Plugs & Covers for Locking-Type Receptacle

Conforms to ANSI C136.10

Model JP-275 keeps lights ON at all times unless turned off from remote location. Gasketed. Contains a short-circuit connection between line and load contacts of receptacle.

Model JP-275 MOV same as JP-275 with 320 joule MOV surge protection.

Model JP-275A weather protective cap only. Keeps lights OFF at all times. Gasketed. Without short-circuit connection between contacts.



GE Astrodome® Electronic Replacements are available. Please call for sales assistance.

603-14



U.L. recognized component



M2A mounted on a wide 90° sweep

Mounting accessories designed for outdoor lighting equipment. Conforms to ANSI/NEMA Standards.

M2A-90 mounted on a long 90° sweep with 3/4 NPT thread on the mounting end. Designed to allow a twistlock control to be properly mounted on a splice box so the control can clear side of box. Photocontrol should always be mounted in a vertical position and should clear the enclosure.

Model Description

M2A	Locking-type receptacle with aluminum angle bracket for wall mounting. With 14" 14 AWG color-coded wire. Dimensions: 2 5/8" diameter (socket), 2 5/8" high (including 1/2" stem). Bracket: 3 1/2" high, 2 3/4" diameter.
M2ANB	Same as M2A without aluminum angle bracket.
M2A-90	See above with 90° sweep.
603-14*	Locking-type receptacle only. With 14" 14 AWG, 105°C, 600V, MTW wire and .150 diameter countersunk holes on 1 15/16" centers. Dimensions: 2 5/8" diameter (socket), 1 3/8" diameter (base), 1 29/64" high.
M2CA	Consists of a 603-14 receptacle with only aluminum mounting ring tapped, two 6/32 x 2" aluminum mounting screws, and sponge rubber gasket.

* UL Recognized and CSA Listed

Dusk to Dawn or Programmed "Off" Control

"ENERGY SAVER"

Twist lock PHOTOCELL/TIMER

Use the MR Series with our ESC-124DS for High Load Capacity, Programmed Off Applications.

ALL LIGHTS DON'T HAVE TO BE ON ALL NIGHT! PROVIDING PROGRAMMED OFF FUNCTION

FOR HIGH LOAD SWITCHING OR MULTIPLE LIGHTING APPLICATIONS

"MR" SERIES - 30 amp model



IDEAL APPLICATIONS:

**Parking Lots • Street Lights • Billboards
Security Lights • Sports Lighting**

LOCKING TYPE

MODEL

**ESC-124DS is
Multi Volt 120/240
1800 VA load
capacity**



**Easy in field adjustment
off time setting on base.**

Precision Utility-Grade Permatrol® Multiple Relays

can be energized by a single photocontrol, providing centralized switching for a group of light fixtures.

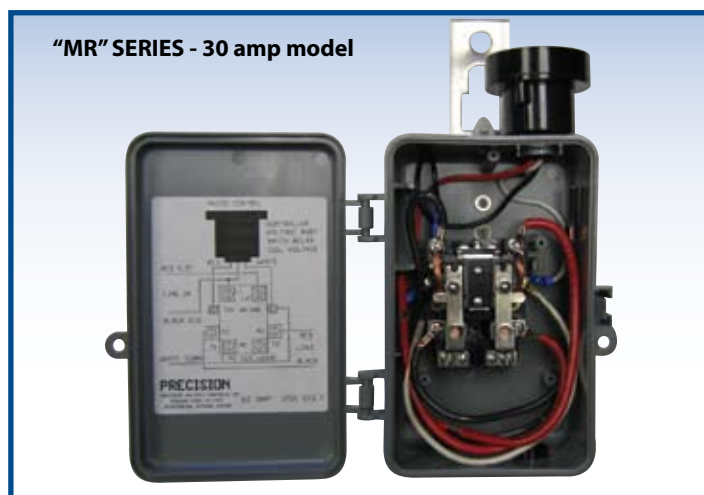

Electromechanical Relays

One contactor covers all applications

Heavy duty magnetic contactor can control either 30 amp or 60 amp lighting loads from one centralized switching location. Excellent for street and highway lighting where the control of multiple circuits is practical and desirable.

Dimensions: 7-7/8" high, 8-5/8" high including mounting bracket, 6" wide, 3-9/16" deep.

Switch: DPDT

Operation: Heavy-duty electromagnetic relay rated for either 30 or 60 amps at 600 VAC.

<u>Model</u>	<u>Coil Volts</u> <u>50/60 HZ</u>	<u>Amp @</u> <u>600 Vac</u>	<u>Switching</u>
MR3030.4	120	30	DPDT
MR3034.4	240	30	DPDT
MR3033.3	277	30	DPDT
MR6060.3	120	60	DPDT
MR6064.3	208-240	60	DPDT
MR6063.3	277	60	DPDT

NOTE: All Permatrol® relays include locking-type receptacle and photocontrols.

See page 6 for photocontrol specifications

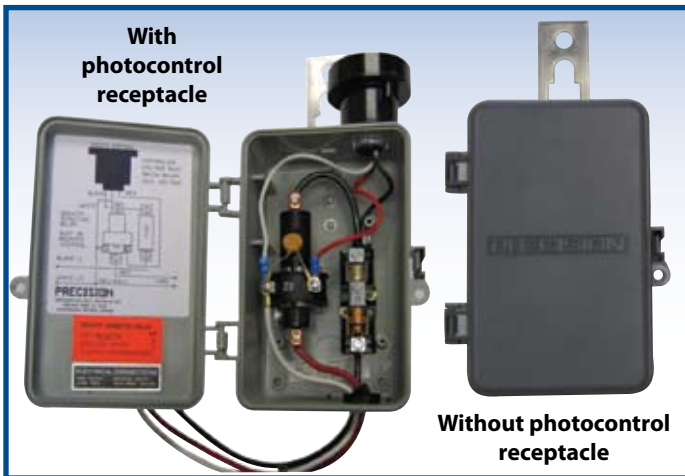

Permatrol® Mercury Relays -

Enclosure: Front door opening, non-metallic, Noryl enclosure. Dimensions: 7-7/8" high, 8-5/8" high including mounting bracket, 6" wide, 3-9/16" deep.

Photocontrol Receptacle: Models available with or without a locking-type photocontrol receptacle mounted to the top of the relay enclosure. Receptacle will accept all locking-type photo-controls that conform to applicable EEI-NEMA standards. (To order relay models with photocontrol receptacle, add suffix "P" to model number.)

Switch: Single-pole, single-throw. Available with either Normally-Open or Normally-Closed switch contacts.

Operation: Extremely reliable mercury relay will operate dependably at 80% of its rated voltage. Its mercury element is hermetically sealed in an inert gas atmosphere. Cool operation with a maximum temperature rise 25° C over ambient on the outside surface of the enclosure. Silent operation with no distracting noise in work areas.

Temperature Range: -40° to 150° F (-40° to 65° C).

Wire Leads: Oil resistant, color-coded lead wire with Class A 105° C insulation. Length: 18". Color-coded: 10 AWG white, 8 AWG black, 8 AWG red. (Models without a receptacle have an additional yellow 10 AWG wire).

Lightning Protection: Equipped with two 320 joule metal oxide varistors (MOV) for protection against line surges.

Fuse: Internal load fuse located for easy access within enclosure.

Permatrol® Relays – SPST			
Model	Contacts Normally	Control Coil Rating	Load 250V Amps
J20113	Open	120 V	30
J20123	Open	240 V	30
J20116	Open	120 V	60
J20126	Open	240 V	60
J21113	Closed	120 V	30
J21123	Closed	240 V	30
J21116	Closed	120 V	60
J21126	Closed	240 V	60

Photocontrols - FAA Series

Built in time delay to prevent false cycling for off switching modes.

Meets all ANSI Standards. See page 7 for receptacles. Conforms to FAA/FCC requirements of 35 FC On and above 60 FC Off.

Model	Voltage	Load	Contacts
102FAA	120 V	1800 VA	SPST – NC
104FAA	240 V	1800 VA	SPST – NC

Hard wire FAA/FCC Photocontrol - Obstruction Light Series

Photocontrol for mounting onto a junction box - 4-3/4" x 4-3/4" splice box. Designed for new obstruction lighting applications or as a direct replacement for Unimar, ABB/SAC, Hughey & Phillips or Crouse Hinds models.

Precision has been manufacturing photocontrols for over 50 years and believes in the building block approach giving the customer the best value for the project. Buy just what you need as opposed to paying for features you don't need and will never need or use!

Most applications can be handled with a SPST 10 amp load rating. Our model PC 502-1 offers considerable cost savings over competitive models with 30 AMP load rating and 2 SPST contacts.

Model	Voltage	Rating	Switch
PC-502-1	120 V	10 A	SPST
PC-502-2	120 V	30 A	2 SPST – contact
PC-502-4	240 V	30 A	2 SPST – contact

Cross Reference

Precision Model	Hughey & Philips®	Crouse Hinds	ABB/SAC®	Unimar®
PC-502-2	PC800-120V	PEC 52009	PCR-10	18001-003
PC-502-4	PC800-240V	PEC 520091-1	PCR-12	18001-0031

Call for special applications or to clarify proper control for the application.

24/7 Series Photocontrol



**NO ADDITIONAL ADAPTER NEEDED.
INTEGRATED PHOTOCONTROL OPERATION IN
ONE LOW-PROFILE HOUSING.**

Photocontrol with Auxiliary Power Supply

Auxiliary grounded power cord receptacle for easy access to 120 volts or 240 volts from light pole. Model 24/7A lights on at night, cord set on 24/7.

Applications: Christmas Lights, Cell Phone & Wi-Fi Transmissions, Security Cameras and More!

Specifications	
Housing:	UV stabilized high-impact polypropylene.
Photocell:	Broad surface sensing element.
Turn-on:	1 to 3 foot-candles.
Turn-on/ off Ratio:	1:3
Time Delay:	Minimum 15 seconds.
Switch Type:	Single-pole, single-throw. Contact position at night normally closed.
Temperature Range:	-40° to 158°F
Power Consumption:	1.1 watts average at 120 VAC.
Rated Life:	5,000 operations minimum at rated load.
Surge Protection:	MOV (Metal Oxide Varistor). 320 joule rating. Add suffix "MOV"

<u>Model</u>	<u>Voltage</u>	<u>Lighting Operation</u>	<u>Cord Set Operation</u>
24/7A	120 V	Lights on at night	Energized at night only
24/7B	120 V	Lights on at night	Energized 24/7
24/7C	240 V	Lights on at night	Energized at night only
24/7D	240 V	Lights on at night	Energized 24/7

To verify voltage, ANSI color codes

(standard photocontrol cover)

Grey	-	120 V
Maroon	-	240 V
Blue	-	105-285 V

Spring Wound Timers



Spring Wound Timers Commercial Grade and Decor Style

Energy Saving Timers that require no electricity to operate.

Commercial Grade

Aluminum Wall plate

PM-15M - 15 minutes on

PM-30M - 30 minutes on

PM-60M - 60 minutes on

PM-12H - 12 hours on

Decor Series

White Wall plate

PD-15M - 15 minutes on

PD-30M - 12 minutes on

PD-60M - 60 minutes on

PD-12H - 12 hours on

APPLICATIONS ARE ENDLESS!

- Indoor / Outdoor Lighting
- Ventilating or Exhaust Fans
- Whirl Pool
- Mini Storage Facilities

Specifications	
SPST Switch Contact Rating (50/60 HZ)	
20A@125VAC (Resistive / Inductive)	
1HP@125VAC (Inductive)	
7A@125VAC (Tungsten)	
10A@250VAC (Resistive / Inductive)	
10A@277VAC (Resistive / Inductive)	
Wiring Connections:	Screw Terminals
Operating Temperatures:	-20°F to 185°F
N.O. and N.C. Terminals	

General Purpose 24 hour Time Switches

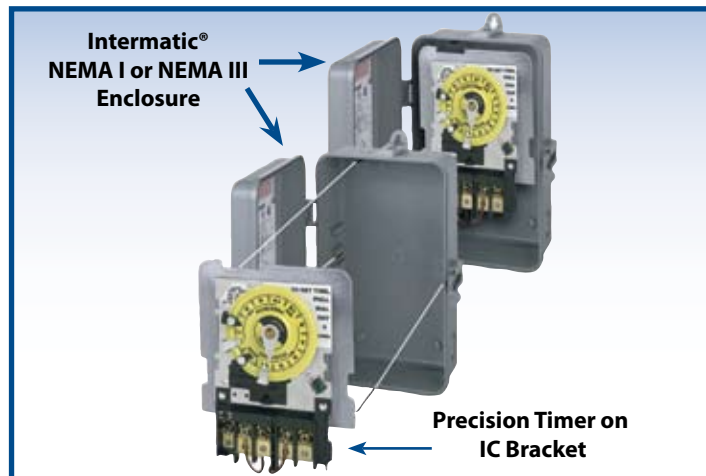

Precision General Purpose NEMA III Models

Noryl® non-conductive Nema III indoor / outdoor enclosure at no extra charge.

Specifications	
Dial:	24 hour dial. Supplied with 2 ON and 2 OFF trippers.
Switch Rating:	40 amps resistive or tungsten, 1000 VA pilot duty, 2 H.P. at 120-277 volts.
Enclosure:	Non-corroding all plastic NEMA 3 case; 9-1/2" high, 5-3/8" wide, 3-1/4" deep. Plastic latch, with hole for lock, holds permanently attached side hinged door closed, with hanging bracket and two holes for mounting.
Knockouts:	5 combination knockouts loaded as follows; 1/2" to 3/4", 2 on bottom, 2 on side and 1 back.
Terminals:	Captive pressure type terminal screws for up to 8 AWG wire.
Operations:	Up to 10 ON/OFF operations per 24 hours. With manual ON/OFF switch that allows circuit to be hand operated without disturbing scheduled setting.
Minimum Settings:	1 hour between ON & OFF. 2 hours between OFF & ON.

Direct Intermatic® Time Switch Replacements (movement only)

Just three Precision compatible brackets allow direct replacement in all NEMA I and NEMA III enclosures of all popular models for Intermatic®, Torq® or Paragon®.

Model	Voltage	AMP	Switch	Intermatic® Model
CD101-IC	120 V	40	SPST	T101, T101P, T101R
CD104-IC	240 V	40	DPST	T104, T104P, T104R

Model	Voltage	AMP	Switch	Tork® Model
CD101-TC	120 V	40	SPST	1101
CD104-TC	240 V	40	DPST	1104

Model	Voltage	AMP	Switch	Paragon® Model
CD101-PC	120 V	40	SPST	4001-00
CD104-PC	240 V	40	DPST	4004-71

Ordering Guideline

Model	Voltage	AMP	Switch	Intermatic®	Tork®	Paragon®
CD101	120 V	40	SPST	T101 or T101P	1101 or 1101N	4001-00
CD102	208-277 V	40	SPST	T102 or T102P	1102 or 1102N	4002-71
CD103	120 V	40	DPST	T103 or T103P	1103 or 1103N	4003-00
CD104	208-277 V	40	DPST	T104 or T104P	1104 or 1104N	4004-71
CD105*	120 V	40	SPDT	T105 or T105P	1105 or 1105N	4005-00
CD106*	208-277 V	40	SPDT	T106 or T106P	1106 or 1106N	4006-71

*Models can switch two non-isolated loads alternately.

208-277 models available in 50 Hz.

® Intermatic is the registered trademark of Intermatic Corporation.

® Tork is the registered trademark of Tork Inc.

® Paragon is the registered trademark of Paragon Corporation.



Freeze Protection For Spas & Pools

Designed to protect pool and spa equipment in those areas where the air temperature can fall below freezing. Frozen water can severely damage pool pumps, piping

and the filter equipment. This is particularly true when the filter pump is in the off mode. The freeze protection control turns the filter pump on to circulate water when the temperature falls below the thermostat setting.

Model FG124 Specifications: • Thermostat 120/240 V • Nema III Enclosure • 1.5 HP@120 VAC • 3 HP@240 VAC

"ENERGY SAVER" DESIGNED TO CUT YOUR OUTDOOR LIGHTING ENERGY COSTS!

YOU DETERMINE HOW MUCH YOU WANT TO SAVE!

**THE COST EFFECTIVE, FAST SOLUTION FOR LIGHTS
THAT DO NOT HAVE TO BE ON ALL NIGHT!**



ESC-124DS

IDEAL APPLICATIONS:

- Parking Lots
- Electrical Signs
- Billboards
- Security Lights
- Sports Lighting



Easy in field setting on base

- Programmable photocell / timer all in one! No need for separate time clock.
- Plug for instant conversion from all night to "programmed" off energy saver mode.
- State-of-the-art technology measures length of night and lets you set "off" time.

- Continually adjusts - never needs resetting!
- Payback in as little as 2 months.

SO EASY TO DO WITH FIXTURES ALREADY EQUIPPED WITH TWISTLOCK RECEPTACLE

- Remove Old Photocell
- Replace with Precision's Energy Saving Multi-Voltage Twistlock (ESC-124DS)
- For Large Lighting Loads See Page 8
- **ENERGY SAVINGS START IMMEDIATELY!**

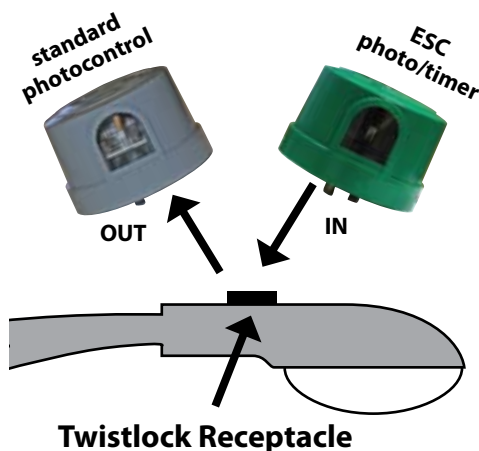

PRECISION

THE #1 SOURCE FOR ENERGY SAVINGS CONTROLS

PRECISION MULTIPLE CONTROLS, INC. - 33 GREENWOOD AVE., MIDLAND PARK, N.J. 07432

CUSTOMER SERVICE ALWAYS AVAILABLE BY PHONE 9am to 5pm weekdays EST

TEL (201) 444-0600 • FAX (201) 445-8575 • www.precisionmulticontrols.com

CANADA: 3055 Lenworth Drive, Unit #9, Mississauga, Ontario L4X 2G3 • Tel (905) 897-6225 • Fax (905) 897-7186